

Introducing your Meridian M3901 Telephone

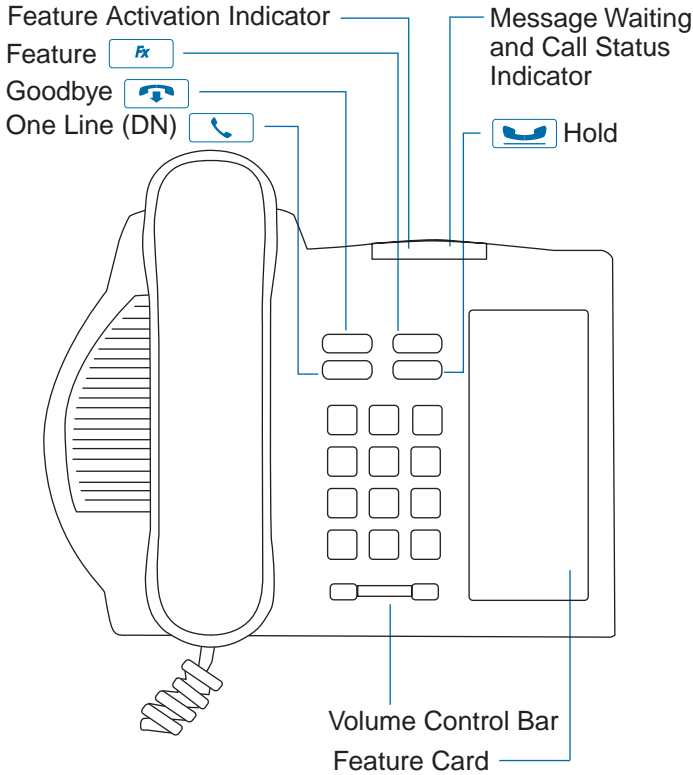

Meridian Digital Telephones

M3901 Quick Reference Card

Features Assigned to Your Telephone

- 1
- 2
- 3
- 4
- 5

Flexible Feature Codes (FFCs)













































Call Forward All Calls Activate	Call Forward All Calls Deactivate
Park Call	Park Call Access
Pickup Ringing Number	Pickup Group
Pickup Directory Number	Group Call
Electronic Lock Activate	Electronic Lock Deactivate
Make Set Busy Activate	Make Set Busy Deactivate
Malicious Call Trace	Override
Ring Again Activate	Ring Again Deactivate
Speed Call User	System Speed Call User



Feature Operation



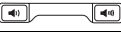
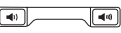









Note 1: Features must be enabled by your network administrator. You only have access to the five features or Auto Dial positions that appear on the feature card of your telephone.

Note 2: When activating features or programming Auto Dial Keys, you have 30 seconds to complete the key sequence or the process ends.

Auto Dial	
store	   A
	 B   A
use	   A
Hold	
place a call on hold	
return to a held call	
Transfer	
transfer a call	  A  C
	  A 
Conference	
create a conference	  A
	 D   A
correct an error or receive busy tone	 
Last Number Redial	
	 
Ring Again	
activate	  A 
when notified	   A
cancel	  A
Speed Call	
store	  A
	 E   A
use	   A  F
Volume Control	
ringing	 (while the telephone is ringing)
handset	 (while on a telephone call)
Deactivate all active features	
	 

For information on using your M3901 telephone when connected to a Meridian SL-100 system, please consult the *Meridian Digital Telephones M3901, M3902, M3903, M3904 User Guide*.

Explanations

Legend	
	Lift the handset, or press  to receive dialtone.
	Replace handset, or press  to end the call.
	Dial a number.
	Press the Line Key.
	Press the Hold Key.
	Press the Goodbye Key.
	Press the Feature Key.
	Press the left side of the Volume Control Bar to lower the volume. Press the right side to increase the volume.
Message Waiting and Call Status Indicator	
On (steady light)	A message is waiting.
Wink (slow flash)	An incoming call is ringing.
Flash	A call is on hold.
Off	There is no message waiting, no call on hold, and no incoming call.
Feature Activation Indicator	
On (steady light)	One or more features are active.
Flash	A feature is being programmed and input is required.
Remarks	
A	Press the Dial Pad Key ( - ) that corresponds to Auto Dial or Feature number on your feature card
B	Use the Dial Pad to enter the number (maximum of 31 characters). Be sure to include any required access codes.
C	Dial the number to which you want to Transfer the call.
D	Dial the number of the party that you want to add to the Conference. You may repeat this process to add up to six people to a Conference Call.
E	Dial the 1 to 3 digit Speed Call code (ask your network administrator if you are unsure about the number of digits used on your network) followed by the telephone number that the code represents (maximum of 31 digits). Be sure to include any required access codes.
F	Dial the 1 to 3 digit Speed Call code.

For additional information on the operation of your telephone, please consult the *Meridian Digital Telephones M3901, M3902, M3903, M3904 User Guide*.